



CO
CO

ARKOSLIGHT



Compacte et puissante

Une nouvelle génération LED avec **154 lm/W**
d'efficacité lumineuse. Le coco est un cylindre compact
en aluminium avec un **flux de 1340 lm**.



Liberté de mouvement

Rotation à **360°** et inclinaison à **90°**.



COCO



20°



34°



48°

COCO 48V TUNABLE WHITE



28°



42°



54°

Liberté d'éclairage

Avec trois angles d'ouverture, **spot / medium / flood** + version **Super spot 12°**.
Le coco couvre de nombreux besoins : éclairage d'accentuation, général...



Coco Super Spot

Hautement technique (**Faisceau 12°**). LED et lentilles de haute qualité soigneusement sélectionnées. Il maintient un flux lumineux uniforme et des niveaux de glare confortables.

Option DIM intégrée

Une intégration parfaite pour les systèmes 48V.
Cette option permet de réguler de **0** à **100** l'intensité
de chaque luminaire de manière indépendante.

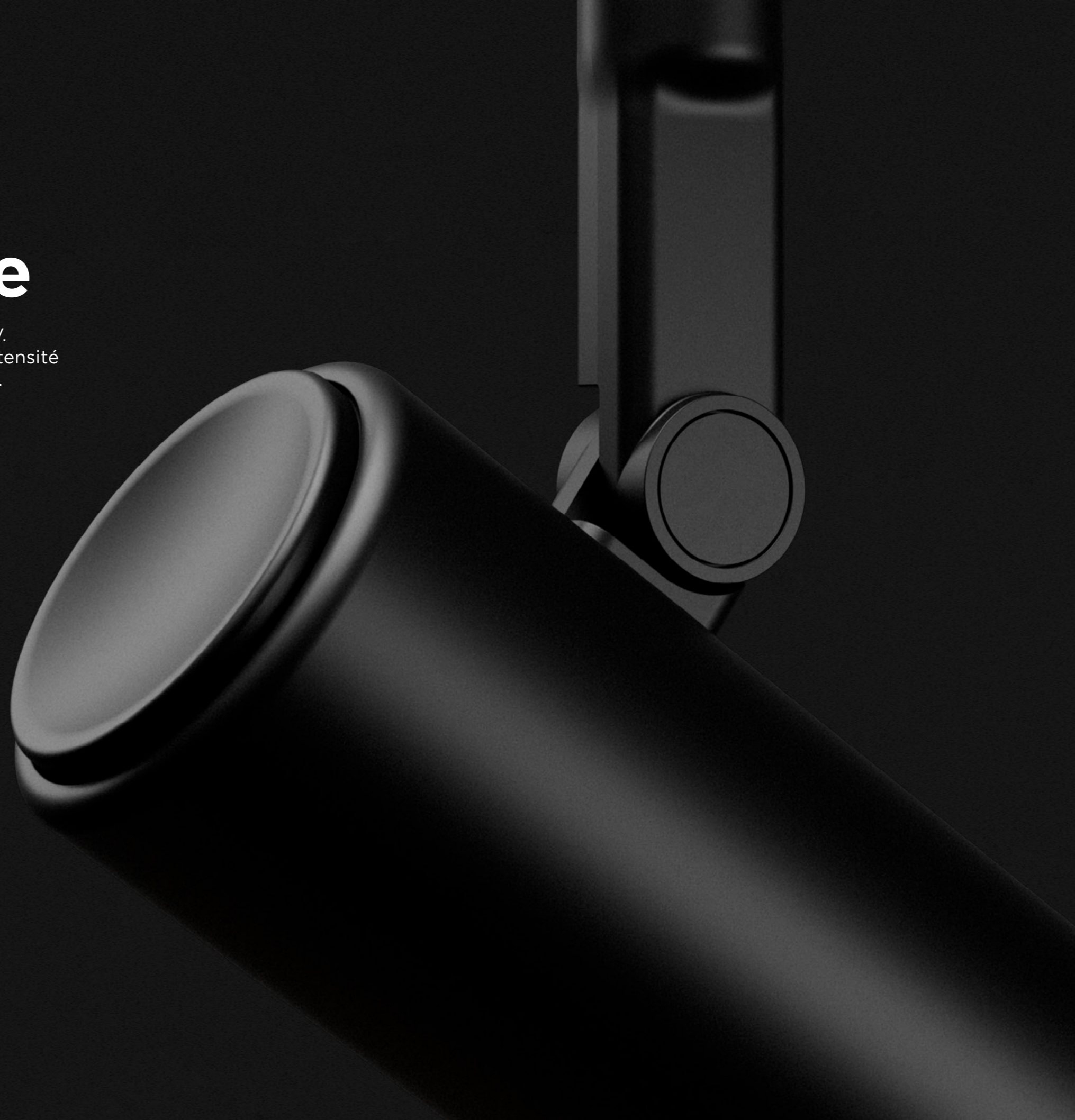

Accessoires

A disposition différents accessoires :
anti-glare honeycomb et **anti-glare screen**,
qui réduisent l'éblouissement et
favorisent le confort visuel.



COCO ANTI-GLARE SCREEN



COCO ANTI-GLARE
HONEYCOMB LOUVER

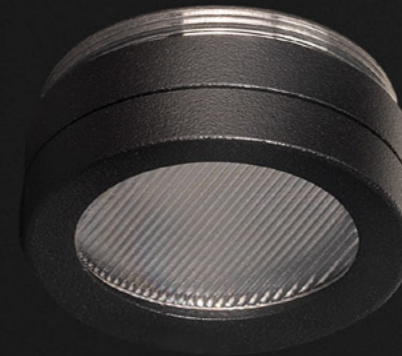



Linear Filter

Ce filtre transforme le faisceau lumineux circulaire en une **forme linéaire**. Idéal pour les applications nécessitant une distribution précise et linéaire de la lumière.



MAGNETIC 24V COCO



8:20h · 3700K



12:00h · 5000K



17:00h · 2700K

Tunable white

Version disponible pour Coco 48V. Très apprécié dans les environnements domestiques, l'hôtellerie, les bureaux, etc.

COCO
SPÉCIFICATIONS
TECHNIQUES





MAGNETIC 24V COCO

OPTIONAL ACCESSORIES

COCO Anti-glare Honeycomb Louver**

A498-90-00- | WT | NT |



COCO Linear Filter**

A498-90-02- | WT | NT |

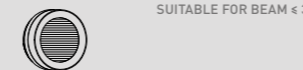

COCO Anti-glare Screen**

A498-90-01- | WT | NT |



COCO High Chromatic Led** ⓘ » 281

NOT SOLD SEPARATELY

TRIMLESS TOOL D16 X D34mm

A478-00-00

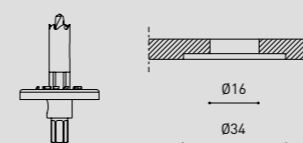

		P	CCT	Beam	I	Flux	LOR
MAGNETIC 24V COCO	A499-00-10- WT NT	8,7W	2700K	20°	500mA	1200 lm	87%
	A499-00-11- WT NT	8,7W	3000K	20°	500mA	1250 lm	87%
	A499-00-12- WT NT	8,7W	4000K	20°	500mA	1340 lm	87%
	A499-00-20- WT NT	8,7W	2700K	34°	500mA	1200 lm	89%
	A499-00-21- WT NT	8,7W	3000K	34°	500mA	1250 lm	89%
	A499-00-22- WT NT	8,7W	4000K	34°	500mA	1340 lm	89%
	A499-00-30- WT NT	8,7W	2700K	48°	500mA	1200 lm	86%
	A499-00-31- WT NT	8,7W	3000K	48°	500mA	1250 lm	86%
	A499-00-32- WT NT	8,7W	4000K	48°	500mA	1340 lm	86%

24 V | ⓘ IP20 | CRI>90 | L80B10 > 66.000h

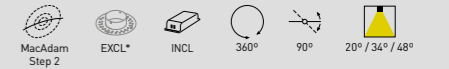

		P	CCT	Beam	I	Flux	LOR
MAGNETIC 24V COCO Super Spot	A499-00-00- WT NT	6W	2700K	12°	500mA	750 lm	66%
	A499-00-01- WT NT	6W	3000K	12°	500mA	800 lm	66%
	A499-00-02- WT NT	6W	4000K	12°	500mA	850 lm	66%

24 V | ⓘ IP20 | CRI>90 | L80B10 > 55.000h

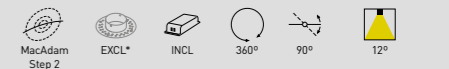

MAGNETIC 24V CONNECTOR A435-01-00 | W | N |

* MANDATORY FOR INSTALLATION

ⓘ IP20 | ⓘ ⌀16

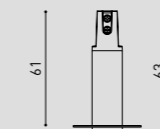
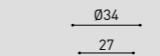

INCLUDED EXTRA COVER FOR RECESSED VERSION

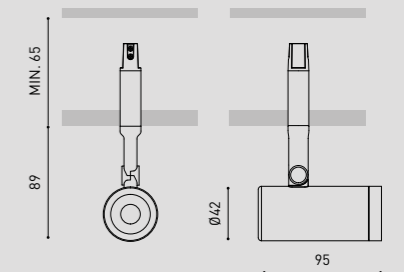

		P	V	D (A x B x C)
24V POWER SUPPLY	0434-01-37	60W	24V	180 x 52 x 30mm
	0433-10-22	100W	24V	295 x 43 x 30mm

220
240 V~ | MUST BE PLACED ON REMOTE

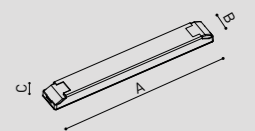

			V	D (A x B x C)
24V DIMMER	0433-01-32	DALI / Push	24V	181 x 42 x 20mm
	0433-01-33	CASAMBI	24V	172 x 42 x 20mm
	0434-01-64	WIFI	24V	105 x 44 x 23mm

24 V | MUST BE PLACED ON REMOTE
OTHER DIM OPTIONS PLEASE CONSULT

ⓘ DROP VOLTAGE » 287

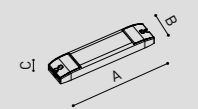

COLOUR | WT □ | NT ■ | MATERIAL | AL | PC/PMMA |

PLEASE CONSULT » ⓘ

OTHER CCT OPTIONS PLEASE CONSULT
** AFFECTS THE LIGHTING PARAMETERS



COCO 48V

OPTIONAL ACCESSORIES

AFFECT THE LIGHTING PARAMETERS

COCO Anti-glare Honeycomb Louver

A498-90-00- | WT | NT |



COCO Anti-glare Screen

A498-90-01- | WT | NT |



COCO Linear Filter

A498-90-02- | WT | NT |

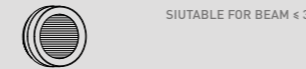

COCO High Chromatic Led

NOT SOLD SEPARATELY

FINISHING

FINISHING	Lamp	Adaptor
WT	WT □ N ■	
NT	NT ■ N ■	
WTW	WT □ W □	
NTW	NT ■ W □	

COCO 48V	+RE	P	CCT	Beam	I	Flux	LOR
A498-0- ① -10- WT NT WTW NTW -S		8,7W	2700K	20°	500mA	1200 lm	87%
A498-0- ① -11- WT NT WTW NTW -S		8,7W	3000K	20°	500mA	1250 lm	87%
A498-0- ① -12- WT NT WTW NTW -S		8,7W	4000K	20°	500mA	1340 lm	87%
A498-0- ① -20- WT NT WTW NTW -S		8,7W	2700K	34°	500mA	1200 lm	89%
A498-0- ① -21- WT NT WTW NTW -S		8,7W	3000K	34°	500mA	1250 lm	89%
A498-0- ① -22- WT NT WTW NTW -S		8,7W	4000K	34°	500mA	1340 lm	89%
A498-0- ① -30- WT NT WTW NTW -S		8,7W	2700K	48°	500mA	1200 lm	86%
A498-0- ① -31- WT NT WTW NTW -S		8,7W	3000K	48°	500mA	1250 lm	86%
A498-0- ① -32- WT NT WTW NTW -S		8,7W	4000K	48°	500mA	1340 lm	86%

48 V | IP20 | CRI>90 | L80B10 >66.000h



COCO 48V Super Spot

COCO 48V Super Spot	+RE	P	CCT	Beam	I	Flux	LOR
A498-0- ① -00- WT NT WTW NTW -S		6W	2700K	12°	500mA	750 lm	66%
A498-0- ① -01- WT NT WTW NTW -S		6W	3000K	12°	500mA	800 lm	66%
A498-0- ① -02- WT NT WTW NTW -S		6W	4000K	12°	500mA	850 lm	66%

48 V | IP20 | CRI>90 | L80B10 >55.000h



COCO 48V Tunable White

COCO 48V Tunable White	+RE	P	CCT	Beam	I	Flux	LOR
A498-12-18- WT NT WTW NTW -S		8,5W	2700-5000K	28°	500mA	1010 lm	85%
A498-12-28- WT NT WTW NTW -S		8,5W	2700-5000K	42°	500mA	1010 lm	87%
A498-12-38- WT NT WTW NTW -S		8,5W	2700-5000K	54°	500mA	1010 lm	84%

48 V | IP20 | CRI>90 | L80B10 >55.000h



*OPTIONS

1	No DIM
2	DIM DALI
7	DIM ON BOARD

OTHER DIM OPTIONS PLEASE CONSULT

+RE REF. ENDING EXAMPLE

0	Track 48V	A4980110WT
-S	Track 48V Short	A4980110WT-S

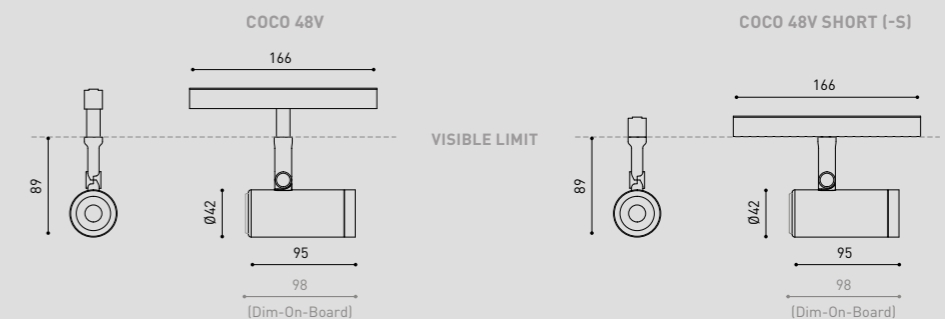

COLOUR | WT □ | NT ■ | MATERIAL | AL | PC/PMMA | PLEASE CONSULT »

OTHER CCT PLEASE CONSULT
 +RE >> THE PRODUCTS FOR THE TRACK 48V SHORT, ADD "-S" AT THE END OF THE SALES REFERENCE (AFTER THE LETTERS WHICH INDICATE THE COLOUR OF THE PRODUCT).

OPTIONAL ACCESSORIES



COCO



COCO SUPER SPOT



COCO ANTI-GLARE HONEYCOMB LOUVER



COCO LINEAR FILTER



COCO ANTI-GLARE SCREEN

FINISHINGS



NT



WT



NTW



WTW



NT



WT



NT SUPER SPOT



WT SUPER SPOT

CO
CO

by ARKOSLIGHT