



**BUDDY**  
**PURPOSEFUL**  
**DESIGN**

ARKOSLIGHT



# Kompakt und leistungsstark

Innovative, hochmoderne LED-Technologie, die äußerst effizient ist. In der Lage, eine Lichtausbeute von bis zu **200lm/W** zu liefern.

Buddy verkörpert die Raffinesse des Downlights mit seinem sorgfältig ausgearbeiteten Design und seinen hochwertigen Oberflächen. Ein kompakter Körper aus Aluminium und präzise Linsen nutzen das volle Potenzial dieser **neuen LED-Generation**.

Mehrere Lichtströme und Leistungsoptionen sind verfügbar, darunter **4W** für **800lm** und **6,6W** für **1220lm**.

# Ein Buddy, viele Optionen

Es gibt zwei Installationsmodi: mit einem **leichten Rahmen** für eine schnelle und effiziente Installation oder **ohne Rahmen** (trimless) für eine vollständig in die Architektur integrierte Installation.

Außerdem gibt es zwei zusätzliche Varianten: **fest** oder **schwenkbar**. Seine schwenkbare Version ist vollständig ausrichtbar und äußerst funktional. Dank seiner Schwenk- und Drehmöglichkeiten können wir nach der Installation mit einer einfachen manuellen Einstellung die Ausrichtung ändern.

Auch in verschiedenen Ausführungen erhältlich.



355°



25°



# Wasserdicht und robust

Dank seiner hohen **IP54-Schutzklasse** ist Buddy selbst in seiner schwenkbaren Version außergewöhnlich beständig gegen das Eindringen von Staubpartikeln und Wasser.



# Beleuchtungs- freiheit, Nut- zungsfreiheit

Die Buddy-Familie bietet außergewöhnliche Vielseitigkeit mit drei Lichtstrahlöffnungsoptionen: **Spot / Medium / Flood** / sowie einer **Super Spot-Version mit 12°**.

Dies macht es zu einem anpassungsfähigen Downlight, ideal für die Abdeckung sowohl von allgemeinen Beleuchtungsbedürfnissen als auch von Akzentbeleuchtung.

Außerdem ist Buddy äußerst technisch. Dank seiner LED, hochwertigen Linsen und blendfreien Bildschirms kann es einen gleichmäßigen Lichtstrom und komfortable Blendungsniveaus gewährleisten und so eine optimale Beleuchtungserfahrung in jeder Umgebung sicherstellen.

## BUDDY

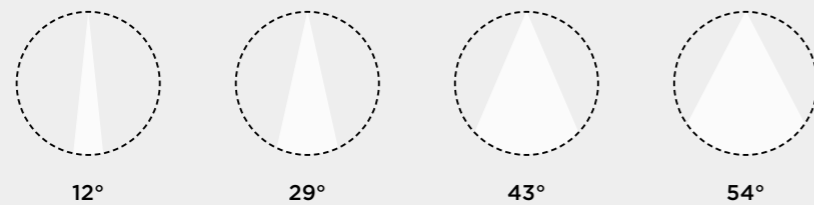

## BUDDY TUNABLE WHITE

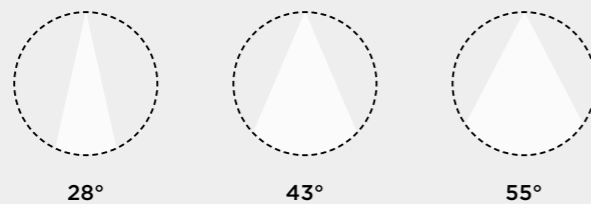

# Buddy Super Spot

Sehr kontrollierte Lichtstrahlöffnung (12°). Konzipiert für den Einsatz als Akzentbeleuchtung, bietet der Buddy Super Spot auch einen gleichmäßigen Lichtstrom und ein deutliches visuelles Komfortgefühl.





100% flux - 3000K



50% flux - 2400K

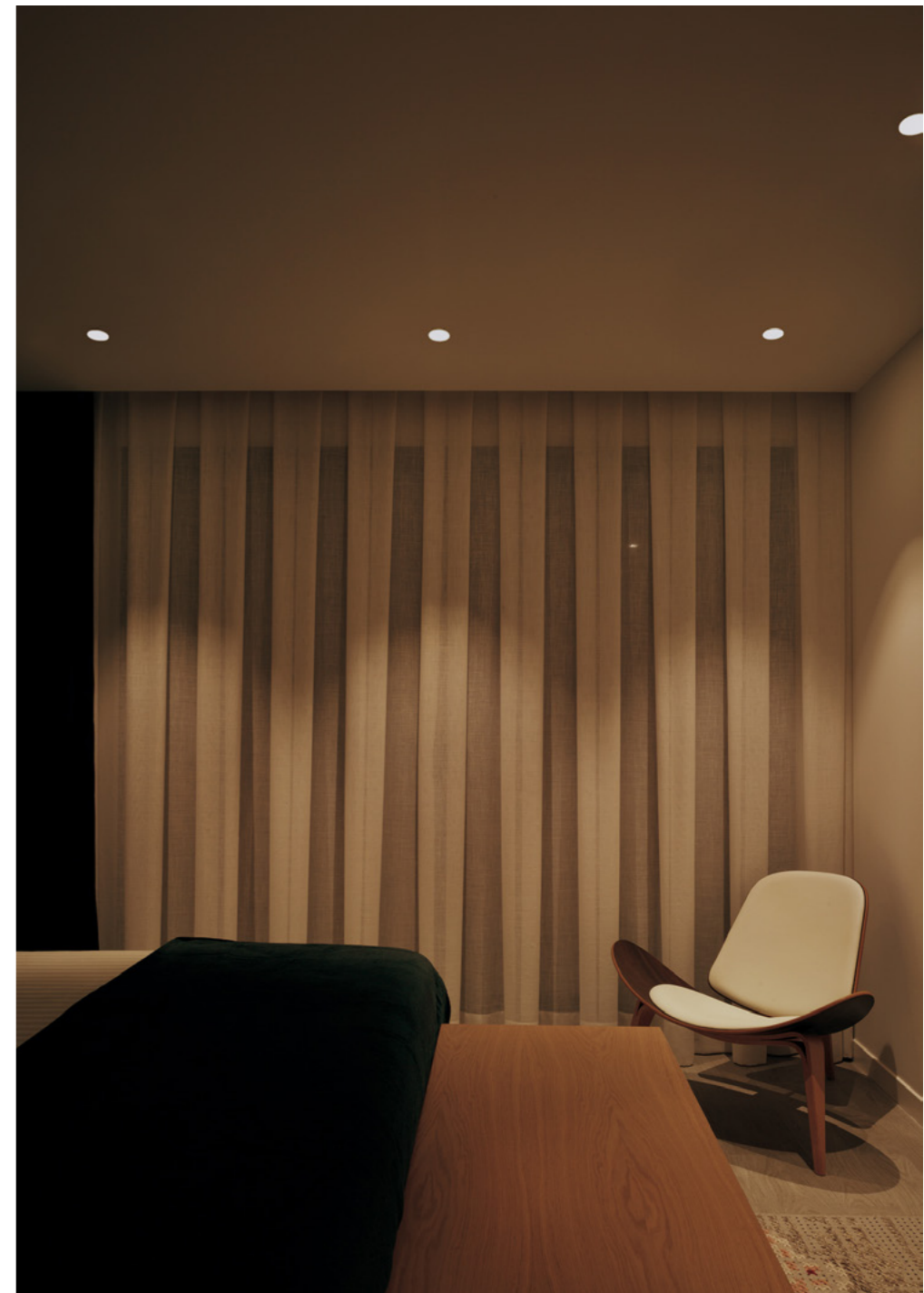

5% flux - 1800K

## DIM to warm

Für Tageszeiten, in denen erhöhte Aktivierung und Biorhythmus angestrebt werden, ist kaltes und helles Licht geeignet. Im Gegensatz dazu sind in Stunden, in denen Deaktivierung und Entspannung angestrebt werden, sind eine warme Lichttemperatur und nur das notwendigste Licht erwünscht.

# Tunable white

Buddy Tunable White ermöglicht eine unabhängige Einstellung der Farbtemperatur und Lichtintensität, was eine vollständige Flexibilität und die Reproduktion des natürlichen Lichts im Laufe des Tages ermöglicht. Diese Technologie trägt zum psychologischen Komfort und Wohlbefinden der Menschen bei.





**BUDDY**  
TECHNISCHE  
SPEZIFIKATIONEN



# VERSIONEN



BUDDY



BUDDY TRIMLESS



BUDDY TILT



BUDDY TILT TRIMLESS

# OBERFLÄCHEN



W



W



N



N



WG



G



NG



WN



# BUDDY

|       |                                     | CCT   |
|-------|-------------------------------------|-------|
| BUDDY | A507-00-0-0-   W   N   WG   NG   WN | 2700K |
|       | A507-00-0-1-   W   N   WG   NG   WN | 3000K |
|       | A507-00-0-2-   W   N   WG   NG   WN | 4000K |

220  
240 V~ | IP54 | CRI>90 | L80B10 > 66.000h

MacAdam Step 2 | EXCL\* | Ø79 | 29° / 43° / 54°

|                     |                                    | CCT   | Beam | LOR |
|---------------------|------------------------------------|-------|------|-----|
| BUDDY<br>Super Spot | A507-00-00-   W   N   WG   NG   WN | 2700K | 12°  | 62% |
|                     | A507-00-01-   W   N   WG   NG   WN | 3000K | 12°  | 62% |
|                     | A507-00-02-   W   N   WG   NG   WN | 4000K | 12°  | 62% |

220  
240 V~ | IP54 | CRI>90 | L80B10 > 55.000h

MacAdam Step 2 | EXCL\* | Ø79 | 12°

|                        |                                    | CCT        | Beam | LOR |
|------------------------|------------------------------------|------------|------|-----|
| BUDDY<br>Tunable White | A507-01-18-   W   N   WG   NG   WN | 2700-5000K | 28°  | 85% |
|                        | A507-01-28-   W   N   WG   NG   WN | 2700-5000K | 43°  | 86% |
|                        | A507-01-38-   W   N   WG   NG   WN | 2700-5000K | 55°  | 81% |

220  
240 V~ | IP54 | CRI>90 | L80B10 > 55.000h

MacAdam Step 3 | EXCL\* | Ø79 | 28° / 43° / 55°

|                      |                                    | CCT        | Beam | LOR |
|----------------------|------------------------------------|------------|------|-----|
| BUDDY<br>DIM to warm | A507-02-39-   W   N   WG   NG   WN | 1800-3000K | 54°  | 75% |

220  
240 V~ | IP54 | CRI>90 | L80B10 > 55.000h

MacAdam Step 3 | EXCL\* | Ø79 | 54°

| ○ | BEAM | LOR |
|---|------|-----|
| 1 | 29°  | 82% |
| 2 | 43°  | 83% |
| 3 | 54°  | 80% |

**OPTIONAL ACCESSORY**

**BUDDY**

**High Chromatic LED**

NOT SOLD SEPARATELY | AFFECTS THE LIGHTING PARAMETERS

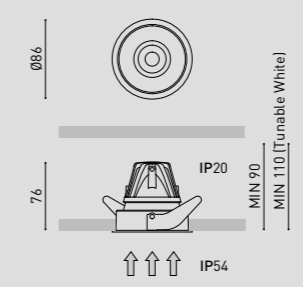

COLOUR | W  | N  | WG  | NG  | WN  | MATERIAL | AL | PC/PMMA |

COLOURS MAY AFFECT THE LIGHTING PARAMETERS  
OTHER CCT OPTIONS PLEASE CONSULT



# BUDDY Trimless

|                |                          | CCT   |
|----------------|--------------------------|-------|
| BUDDY Trimless | A507-10-0-0-   W   N   G | 2700K |
|                | A507-10-0-1-   W   N   G | 3000K |
|                | A507-10-0-2-   W   N   G | 4000K |

220 V~ | IP20 | CRI>90 | L80B10 >66,000h

MacAdam Step 2 | EXCL\* | EXCL\*\* | Ø79 | 29° / 43° / 54°

|                           |                         | CCT   | Beam | LOR |
|---------------------------|-------------------------|-------|------|-----|
| BUDDY Trimless Super Spot | A507-10-00-   W   N   G | 2700K | 12°  | 62% |
|                           | A507-10-01-   W   N   G | 3000K | 12°  | 62% |
|                           | A507-10-02-   W   N   G | 4000K | 12°  | 62% |

220 V~ | IP20 | CRI>90 | L80B10 >55,000h

MacAdam Step 2 | EXCL\* | EXCL\*\* | Ø79 | 12°

|                              |                         | CCT        | Beam | LOR |
|------------------------------|-------------------------|------------|------|-----|
| BUDDY Trimless Tunable White | A507-11-18-   W   N   G | 2700-5000K | 28°  | 85% |
|                              | A507-11-28-   W   N   G | 2700-5000K | 43°  | 86% |
|                              | A507-11-38-   W   N   G | 2700-5000K | 55°  | 81% |

220 V~ | IP20 | CRI>90 | L80B10 >55,000h

MacAdam Step 3 | EXCL\* | EXCL\*\* | Ø79 | 28° / 43° / 55°

|                            |                         | CCT        | Beam | LOR |
|----------------------------|-------------------------|------------|------|-----|
| BUDDY Trimless DIM to warm | A507-12-39-   W   N   G | 1800-3000K | 54°  | 75% |

220 V~ | IP20 | CRI>90 | L80B10 >55,000h

MacAdam Step 3 | EXCL\* | EXCL\*\* | Ø79 | 54°

| BEAM  | LOR |
|-------|-----|
| 1 29° | 82% |
| 2 43° | 83% |
| 3 54° | 80% |

**ACCESSORY**

**BUDDY Trimless Accessory\*\***

**A507-10-90**

MANDATORY FOR INSTALLATION

**OPTIONAL ACCESSORIES**

**BUDDY Trimless High Chromatic LED**

NOT SOLD SEPARATELY | AFFECTS THE LIGHTING PARAMETERS

**TRIMLESS TOOL D79 X D120mm**

**A478-00-05**

COLOUR | W □ | N ■ | G ■ | MATERIAL | AL | PC/PMMA

COLOURS MAY AFFECT THE LIGHTING PARAMETERS  
OTHER CCT OPTIONS PLEASE CONSULT



# BUDDY Tilt

|            |                                     | CCT   |  |
|------------|-------------------------------------|-------|--|
| BUDDY Tilt | A508-00-0-0-   W   N   WG   NG   WN | 2700K |  |
|            | A508-00-0-1-   W   N   WG   NG   WN | 3000K |  |
|            | A508-00-0-2-   W   N   WG   NG   WN | 4000K |  |

220 V~ | III IP54 | CRI>90 | L80B10 > 66.000h

MacAdam Step 2 EXCL\* 355° 25° Ø79 28° / 43° / 54°

|                       |                                    | CCT   | Beam | LOR |
|-----------------------|------------------------------------|-------|------|-----|
| BUDDY Tilt Super Spot | A508-00-00-   W   N   WG   NG   WN | 2700K | 12°  | 62% |
|                       | A508-00-01-   W   N   WG   NG   WN | 3000K | 12°  | 62% |
|                       | A508-00-02-   W   N   WG   NG   WN | 4000K | 12°  | 62% |

220 V~ | III IP54 | CRI>90 | L80B10 > 55.000h

MacAdam Step 2 EXCL\* 355° 25° Ø79 12°

|                          |                                    | CCT        | Beam | LOR |
|--------------------------|------------------------------------|------------|------|-----|
| BUDDY Tilt Tunable White | A508-01-18-   W   N   WG   NG   WN | 2700-5000K | 28°  | 85% |
|                          | A508-01-28-   W   N   WG   NG   WN | 2700-5000K | 43°  | 86% |
|                          | A508-01-38-   W   N   WG   NG   WN | 2700-5000K | 55°  | 81% |

220 V~ | III IP54 | CRI>90 | L80B10 > 55.000h

MacAdam Step 3 EXCL\* 355° 25° Ø79 28° / 43° / 55°

|                        |                                    | CCT        | Beam | LOR |
|------------------------|------------------------------------|------------|------|-----|
| BUDDY Tilt DIM to warm | A508-02-39-   W   N   WG   NG   WN | 1800-3000K | 54°  | 75% |

220 V~ | III IP54 | CRI>90 | L80B10 > 55.000h

MacAdam Step 3 EXCL\* 355° 25° Ø79 54°

| ○ | BEAM | LOR |
|---|------|-----|
| 1 | 29°  | 82% |
| 2 | 43°  | 83% |
| 3 | 54°  | 80% |

## OPTIONAL ACCESSORY

### BUDDY Tilt

#### High Chromatic LED

NOT SOLD SEPARATELY | AFFECTS THE LIGHTING PARAMETERS

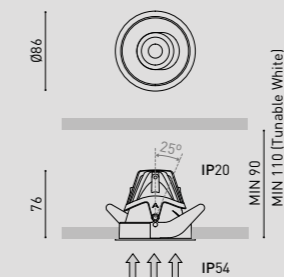

COLOUR | W □ | N ■ | WG □ | NG ■ | WN □ | MATERIAL | AL | PC/PMMA

COLOURS MAY AFFECT THE LIGHTING PARAMETERS  
OTHER CCT OPTIONS PLEASE CONSULT



# BUDDY Tilt Trimless

|                     |                          | CCT   |  |
|---------------------|--------------------------|-------|--|
| BUDDY Tilt Trimless | A508-10-0-0-   W   N   G | 2700K |  |
|                     | A508-10-0-1-   W   N   G | 3000K |  |
|                     | A508-10-0-2-   W   N   G | 4000K |  |

220 V~ | 240 V~ | IP20 | CRI>90 | L80B10 > 66.000h

MacAdam Step 2 | EXCL\* | EXCL\*\* | 25° | Ø79 | 29° / 43° / 54°

|                                |                         | CCT   | Beam | LOR |
|--------------------------------|-------------------------|-------|------|-----|
| BUDDY Tilt Trimless Super Spot | A508-10-00-   W   N   G | 2700K | 12°  | 62% |
|                                | A508-10-01-   W   N   G | 3000K | 12°  | 62% |
|                                | A508-10-02-   W   N   G | 4000K | 12°  | 62% |

220 V~ | 240 V~ | IP20 | CRI>90 | L80B10 > 55.000h

MacAdam Step 2 | EXCL\* | EXCL\*\* | 25° | Ø79 | 12°

|                                   |                         | CCT        | Beam | LOR |
|-----------------------------------|-------------------------|------------|------|-----|
| BUDDY Tilt Trimless Tunable White | A508-11-18-   W   N   G | 2700-5000K | 28°  | 85% |
|                                   | A508-11-28-   W   N   G | 2700-5000K | 43°  | 86% |
|                                   | A508-11-38-   W   N   G | 2700-5000K | 55°  | 81% |

220 V~ | 240 V~ | IP20 | CRI>90 | L80B10 > 55.000h

MacAdam Step 3 | EXCL\* | EXCL\*\* | 25° | Ø79 | 28° / 43° / 55°

|                                 |                         | CCT        | Beam | LOR |
|---------------------------------|-------------------------|------------|------|-----|
| BUDDY Tilt Trimless DIM to warm | A508-12-39-   W   N   G | 1800-3000K | 54°  | 75% |

220 V~ | 240 V~ | IP20 | CRI>90 | L80B10 > 55.000h

MacAdam Step 3 | EXCL\* | EXCL\*\* | 25° | Ø79 | 54°

| Ø | BEAM | LOR |
|---|------|-----|
| 1 | 29°  | 82% |
| 2 | 43°  | 83% |
| 3 | 54°  | 80% |

**ACCESSORY**

**BUDDY Tilt Trimless Accessory\*\***

**A508-10-90**

MANDATORY FOR INSTALLATION

Ø79

**OPTIONAL ACCESSORIES**

**BUDDY Tilt Trimless High Chromatic LED** ⓘ » 281



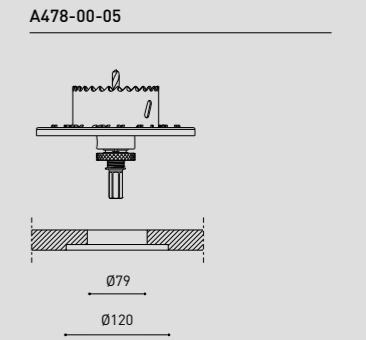
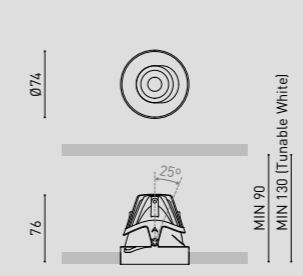







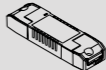
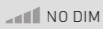
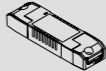
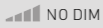
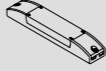

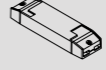
NOT SOLD SEPARATELY | AFFECTS THE LIGHTING PARAMETERS

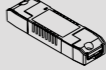
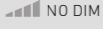
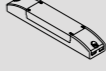

COLOUR | W | N | G | MATERIAL | AL | PC/PMMA

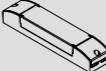
COLOURS MAY AFFECT THE LIGHTING PARAMETERS  
OTHER CCT OPTIONS PLEASE CONSULT

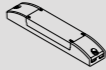
# DRIVERS

| *DRIVER OPTIONS     |   |   |            | P    | I     | CCT        | Flux    |
|---------------------|---|---|------------|------|-------|------------|---------|
| BUDDY 1             |    |  NO DIM    | 0434-01-85 | 4W   | 125mA | 2700K      | 760 lm  |
|                     |   |   |            |      |       | 3000K      | 790 lm  |
|                     |   |   |            |      |       | 4000K      | 800 lm  |
|                     |    |  NO DIM    | 0434-01-86 |      |       |            |         |
| BUDDY 2             |    |  DALI      | 0434-01-89 | 6,6W | 200mA | 2700K      | 1150 lm |
|                     |   |   |            |      |       | 3000K      | 1200 lm |
|                     |   |   |            |      |       | 4000K      | 1220 lm |
|                     |    |  CASAMBI   | 0434-01-91 |      |       |            |         |
|                     |    |  PHASE CUT | 0434-01-92 |      |       |            |         |
| BUDDY Super Spot    |    |  NO DIM    | 0434-01-87 | 6W   | 500mA | 2700K      | 750 lm  |
|                     |   |   |            |      |       | 3000K      | 790 lm  |
|                     |    |  DALI      | 0434-01-88 |      |       | 4000K      | 845 lm  |
| BUDDY Tunable White |  |  DALI    | 0434-01-90 | 6,7W | 400mA | 2700-5000K | 815 lm  |
| BUDDY DIM to warm   |  |  DALI    | 0434-01-94 | 6W   | 350mA | 1800-3000K | 650 lm  |
|                     |   |   |            |      |       |            |         |

220 V~ | 48V PLEASE CONSULT  
240



**BUDDY**  
**PURPOSEFUL**  
**DESIGN**

by **ARKOSLIGHT**